USER MANUAL

**MODEL NUMBER:
FI-STATION
FI-STDF
FI-STSAN
AND RELATED UNITS**

Central Foam or Foam/Sanitize Station

English (Original Instructions)

READ ALL INSTRUCTIONS BEFORE OPERATING EQUIPMENT



WARNING



Read this manual completely and understand the machine before operating or servicing it.

- Read all instructions before installing, operating, servicing, or interacting with this unit.
- Always wear appropriate personal protective equipment (PPE) when operating or servicing unit.
- Always follow all chemical safety precautions and handling instructions provided by the chemical manufacturer and Material Safety Data Sheet (MSDS).
- If this unit is modified or serviced with parts not listed in this manual, the unit may not operate correctly.
- Never point the discharge wand/trigger gun at yourself, another person, or any object you do not want covered in chemical.
- Always depressurize unit after use (as described in the After Use Instructions). Always store unit with the discharge ball valve/trigger gun in the closed position.
- Do not exceed an incoming air pressure of 100 psi (6.9 bar).
- Do not exceed a fluid temperature of 100°F (37.8°C).
- Only use clean and dry air. Air must be filtered and free of moisture or pump life will be diminished. If needed, install an air dryer before unit.
- Do not use an air lubricator before the unit.

PROTECT THE ENVIRONMENT

Please dispose of packaging materials, old machine components, and hazardous fluids in an environmentally safe way according to local waste disposal regulations.



Always remember to recycle.

*Specifications and parts are subject to change without notice.

Specifications:

Foam Hose ... 50 feet reinforced hose, 3/4 inch inside diameter
(15.2 meters reinforced hose, 19 mm inside diameter)
Foam Output 20 to 45 gallons/minute
(75.7 to 170.3 liters/minute)
Foaming Distance 25 to 30 feet (7.6 to 9.1 meters)

For units that include a spray system:

Spray Hose 50 feet reinforced hose, 3/8 inch inside diameter
(15.2 meters reinforced hose, 9.5 mm inside diameter)
Spray Output 2 gallons/minute (7.6 liters/minute)
Spraying Distance 10 to 12 feet (3 to 3.7 meters)

Requirements:

Compressed Air Pressure Requirements:

Air regulator factory set at 50 psi (3.4 bar). Operating range is 40 to 80 psi (2.8 to 5.5 bar) with 3.5 to 8 CFM (99.1 to 226.5 l/min).

Chemical Requirements:

Follow all instructions from chemical manufacturer and Material Safety Data Sheet (MSDS).

Pre-mixed chemical solution must be supplied by a properly-sized header system at 2 GPM and 40 to 80 PSI (2.8 to 5.5 bar).
Note: Units that include a spray system require two chemical solution supply systems.

Liquid Temperature 40°F to 100°F (4.4°C to 37.8°C)

Acceptable Products:

Alkaline cleaners, Caustic cleaners, Sanitizers, and Acids

* D-Limonene may only be used with Kalrez pump

* Chlorine may only be used with Viton or Kalrez pump

DO NOT USE: All hydrocarbons

READ ALL INSTRUCTIONS BEFORE OPERATING EQUIPMENT

Installation Instructions:

Note: This unit is designed to be part of a centrally-supplied system. The unit requires a chemical solution source, supplied by a pump that is capable of delivering the solution to the unit at an appropriate pressure and volume. We recommend that a proportioner or injector be used when mixing the chemical solution, to help ensure consistent dilution.

1. Remove all components from packaging.
2. Select desired area to mount the control box.
3. Attach the control box mounting feet to the back of the control box, using the four screws provided in the parts package.
4. Mount the control box to the wall using four of the screws and plastic anchors provided in the parts package.
Note: To drill holes for the plastic anchors, use a $\frac{5}{16}$ inch drill bit.
5. Mount the hose hanger in a convenient location using the remaining two screws and anchors provided in the parts package.
6. Attach the discharge hose assembly to the discharge hose barb and secure it with the hose clamp provided in the parts package.
7. For units that include a spray system, attach the spray hose assembly to the spray discharge hose barb, and secure it with the hose clamp provided in the parts package.
8. Connect the air inlet hose barb provided in the parts package to the air inlet valve located on the side of the control box. Then attach a $\frac{3}{8}$ inch I.D. air line from your air compressor to the air inlet hose barb, and secure it with the smaller hose clamp provided in the parts package.
9. Connect a centrally-supplied chemical solution line to the inlet barb located on the top of the unit. The check valve must be installed between the incoming chemical solution line and the unit.
Note: On new installations, make sure to flush the central system lines with water before connecting the unit. This helps remove any debris in the lines that could negatively impact the function of the unit.
10. If needed, reduce the solution flow rate by adjusting the flow control valve, located inside the control box.
11. For units that include a spray system, connect a centrally-supplied chemical solution line to the spray inlet barb, located on the top of the control box.
Note: On new installations, make sure to flush the central system lines with water before connecting the unit. This helps remove any debris in the lines that could negatively impact the function of the unit.

Operation Instructions:

1. Follow all instructions from chemical manufacturer.
2. With the discharge ball valve in the closed position, open the solution inlet valve and the air inlet valve.
3. Slowly open the discharge ball valve to begin foaming. The discharge ball valve should be completely open while foaming.
4. While the unit is running and discharging product, adjust the needle valve, located inside the control box, as needed to regulate the wetness or dryness of the foam following the steps below:
 - a. Close needle valve completely in clockwise direction.
 - b. Open needle valve in counter-clockwise direction 3 complete turns.
 - c. Continue to open needle valve in $\frac{1}{4}$ turn increments, allowing 30 seconds between adjustments, until desired consistency of foam is achieved.
5. Adjust the air regulator, located inside the control box, as needed to ensure proper foam pressure. The air regulator is factory set at 50 psi (3.4 bar), but the pressure may need to be increased or decreased – the air pressure should be roughly equivalent to the incoming solution pressure.
6. Close the discharge ball valve to stop foaming.
7. For units that include a spray system, open the spray solution inlet valve and squeeze the discharge trigger gun to begin spraying. Release the discharge trigger gun to stop spraying.

After Use Instructions:

We recommend depressurizing the unit after each use.

1. Close the discharge ball valve/trigger gun.
2. Shut off the air supply to the unit by closing the air inlet valve.
3. Shut off the chemical solution supply to the unit by closing the solution inlet valve(s).
4. Open the discharge ball valve/trigger gun to relieve any pressure remaining in the unit.
5. Close the discharge ball valve/trigger gun after all pressure has been relieved from the unit. Store the unit with the discharge ball valve/trigger gun in the closed position.

READ ALL INSTRUCTIONS BEFORE OPERATING EQUIPMENT

Maintenance Instructions:

To keep your foam unit operating properly, periodically perform the following maintenance procedures:

Note: Before performing any maintenance, ensure that the unit has been depressurized according to the "After Use Instructions."

- Inspect all hoses for leaks or excessive wear. Make sure all hose clamps are in good condition and properly secured

Troubleshooting Instructions:

- Check to ensure that the discharge hose is uncoiled properly, and that there are no kinks that could obstruct discharge flow.
- If foam discharge is inconsistent or sporadic, the needle valve and/or air regulator may be set improperly. If this occurs, readjust the needle valve and air regulator as described in Operation Instructions #4 - 5.
- Make sure proper foaming chemical and concentration are being used.
- If solution backs up into the air regulator, the check valve needs to be replaced.
- If foam comes out wet, no matter where the needle valve is positioned, the check valve may need to be replaced.
- If the unit operates at a reduced pressure:
- Check the air compressor supplying the unit. If the pressure is too low, turn the unit off to allow the compressor to catch up.
- If the air supply to the unit is sufficient, check the air gauge inside the control box. The air pressure should be roughly equivalent to the incoming solution pressure.
- If solution flow is reduced, the flow control valve may be plugged or obstructed, or set incorrectly. Try to reset the valve by closing and opening it several times and then resetting it to the desired flow. If the problem persists, the valve may need to be removed and cleaned or replaced. If you find that the valve is plugged or obstructed, determine the source of the obstruction and correct it to avoid future problems.

READ ALL INSTRUCTIONS BEFORE OPERATING EQUIPMENT

PARTS DIAGRAMS - FOAM STATION

CONTROL BOX ASSEMBLY

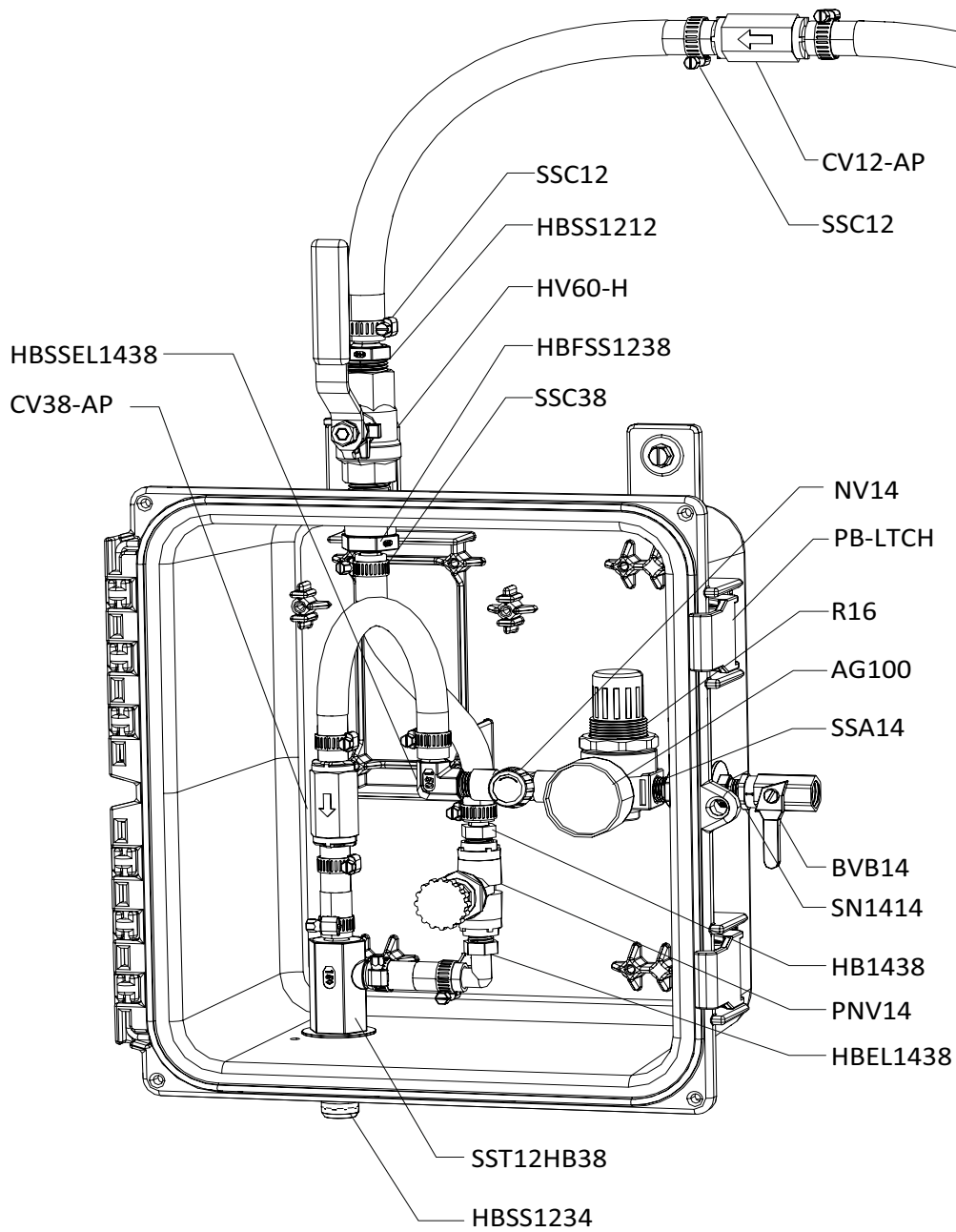

READ ALL INSTRUCTIONS BEFORE OPERATING EQUIPMENT

PARTS DIAGRAMS - DUAL FOAM STATION

CONTROL BOX ASSEMBLY

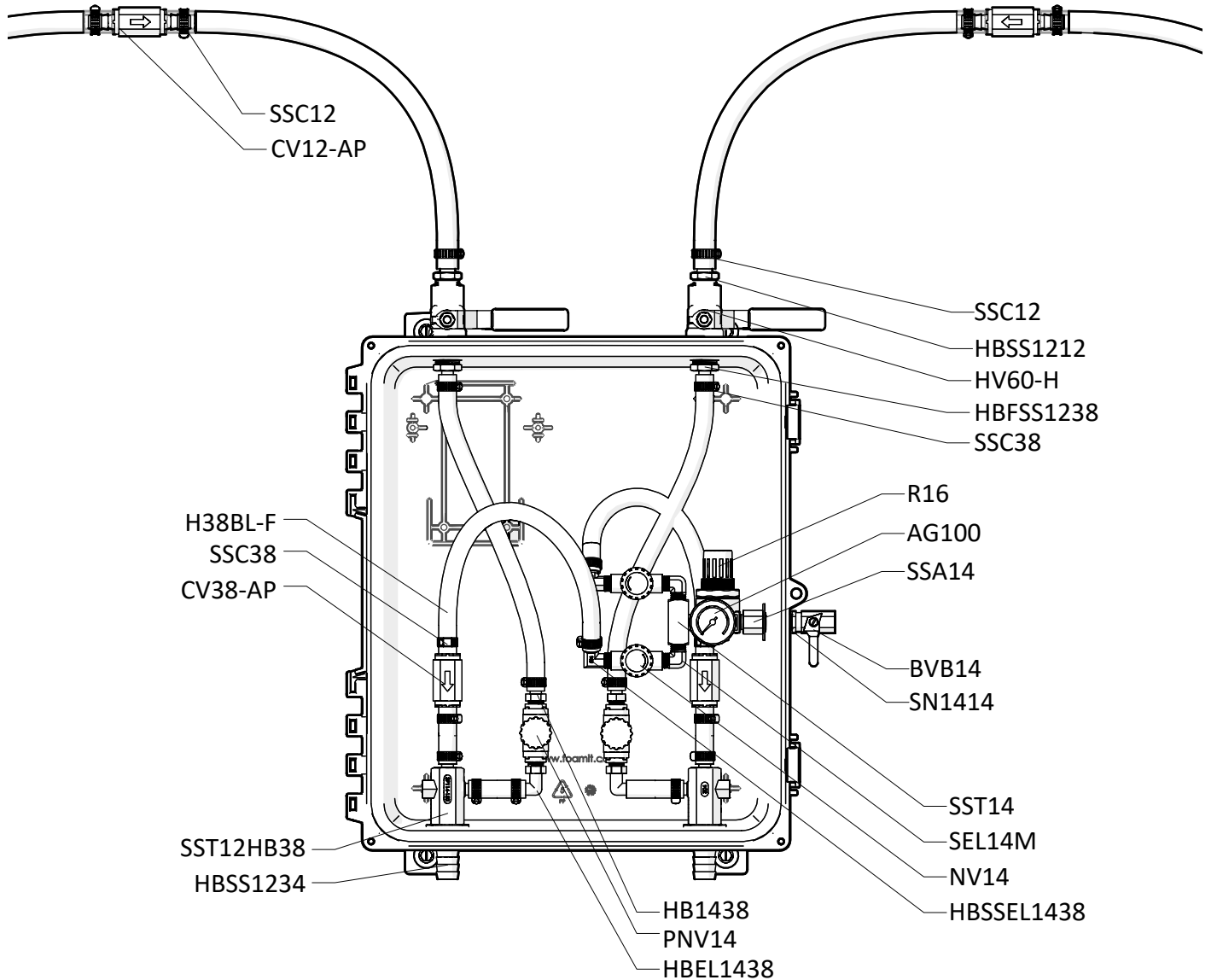

READ ALL INSTRUCTIONS BEFORE OPERATING EQUIPMENT

PARTS DIAGRAMS - FOAM AND SPRAY STATION

CONTROL BOX ASSEMBLY

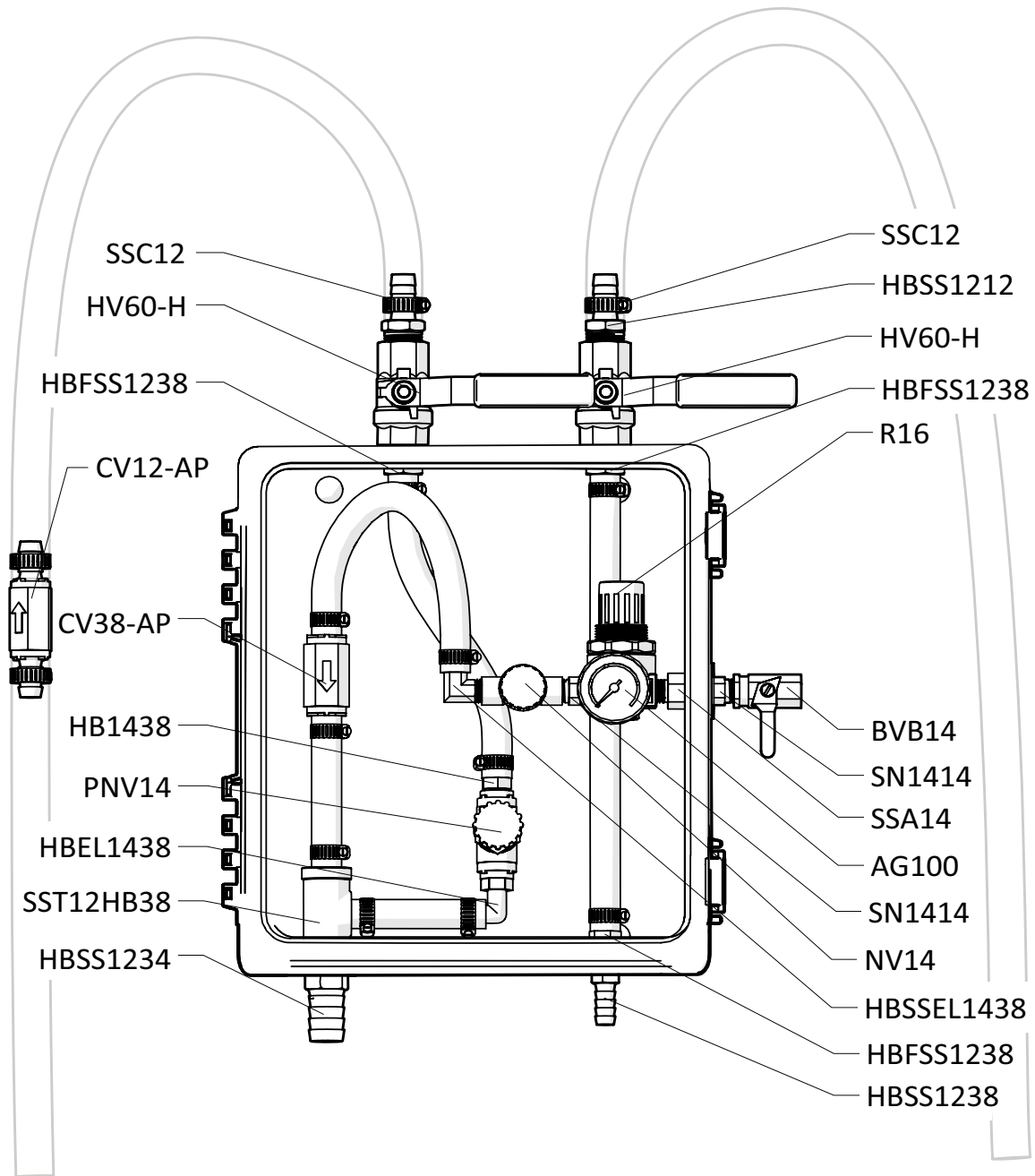

READ ALL INSTRUCTIONS BEFORE OPERATING EQUIPMENT

PARTS DIAGRAMS - FOAM WAND AND SPRAY GUN

HOSE AND ZERO TIP FOAM WAND ASSEMBLY

ITEM NUMBER: SSWA347-HA34BL-50

ZERO TIP FOAM WAND ASSEMBLY
ITEM NUMBER: SSWA347

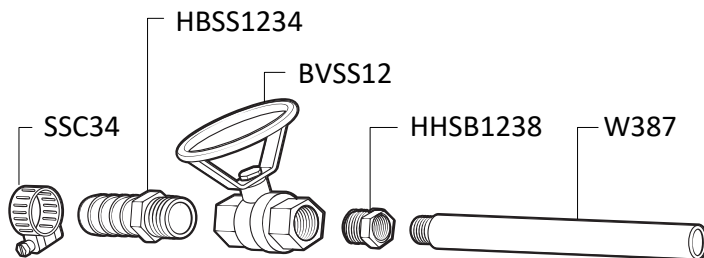

50 ft (15 m) FOAM HOSE ASSEMBLY
ITEM NUMBER: HA34BL-50

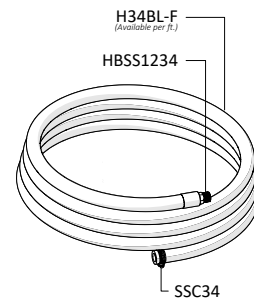

SPRAY GUN AND HOSE ASSEMBLY

ITEM NUMBER: PSGA384-ST-HA38BL-50

SPRAY GUN ASSEMBLY
ITEM NUMBER: PSGA384-ST

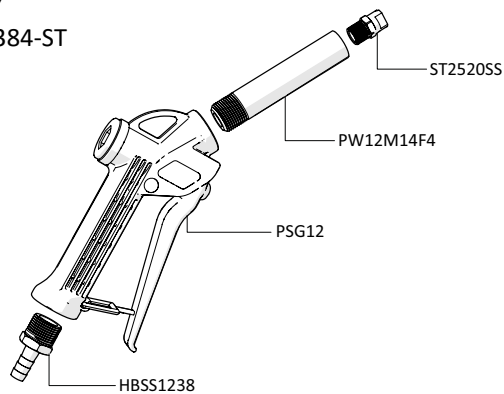

50 ft (15 m) SPRAY HOSE ASSEMBLY
ITEM NUMBER: HA38BL-50

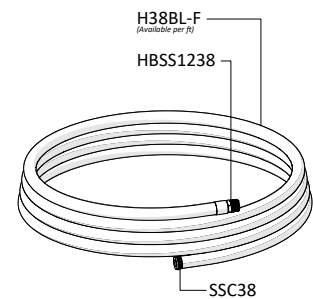

FAN TIP FOAM WAND ASSEMBLY

ITEM NUMBER: PWA3410-ST

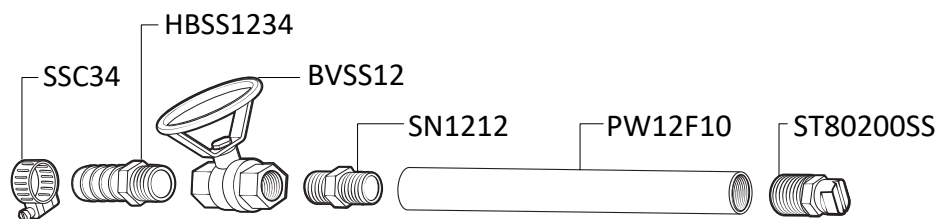

READ ALL INSTRUCTIONS BEFORE OPERATING EQUIPMENT

ITEM NUMBER	DESCRIPTION
AG100	AIR GAUGE-1/8IN NPT-100 PSI DRY MODEL
AKSS34	SS ANTI-KINK SPRING FOR 3/4 INCH HOSE
BVB14	AIR INLET VALVE-1/4IN FPT X 1/4IN FPT
BVSS12	STAINLESS BALL VALVE-1/2IN NPT
CV12-AP	WHITE PVC CHECK VALVE 1/2 BARBS - HASTELLOY SPRING - TEFLON BALL - VITON SEAL
CV38-AP	CHECK VALVE-3/8IN BARBS-PVC BODY-HASTELLOY SPRING-TEFLON BALL-WHITE
F34SS	STAINLESS CRIMP FERRULE FOR 3/4IN HOSE
F38SS	STAINLESS 3/8 INCH FERRULE
FW14NPT	FLAT WASHER FOR 1/4IN NPT - STAINLESS - 0.57IN ID X 1.28IN OD X 0.08IN THK
FW12NPT	FLAT WASHER FOR 1/2IN NPT - STAINLESS - 0.88IN ID X 1.5IN OD X 0.05IN THK
FW12NPT-THK	FLAT WASHER FOR 1/2IN NPT - THICK - STAINLESS - 0.88IN ID X 1.5IN OD X 0.12IN THK
H12CL-CB	1/2IN ID CLEARBRAID HOSE - PVC - AVAILABLE PER FT
H34BL-F	3/4IN BLUE HOSE-HYBRID TPE-AVAILABLE PER FT
H38BL-F	3/8IN BLUE HOSE-HYBRID TPE-AVAILABLE PER FT
HB1438	1/4in MPT X 3/8in HOSE BARB (PLASTIC)
HBEL1438	HOSE BARB ELBOW 1/4 MPT X 3/8 HOSE BARB
HBFSS1238	STAINLESS STEEL HOSE BARB 1/2 FPT X 3/8 BARB
HBSS1212	STAINLESS HOSE BARB 1/2 MPT X 1/2 BARB
HBSS1234	STAINLESS HOSE BARB 1/2 MPT X 3/4 BARB
HBSS1438	STAINLESS HOSE BARB 1/4 MPT X 3/8 BARB
HBSEL1438	STAINLESS HOSE BARB 1/4 MPT X 3/8 BARB ELBOW
HHSB1214	HEX HEAD STAINLESS BUSHING 1/2 MPT X 1/4 FPT
HHSB1238	HEX HEAD STAINLESS BUSHING 1/2 MPT X 3/8 FPT
HV60-H	1/2IN STAINLESS BALL VALVE - STRAIGHT HANDLE - NO WELDED NUT
NV14	NEEDLE VALVE-1/4IN NPT-INCLUDES BLACK KNOB
NV14-HNDL	BLACK KNOB FOR NEEDLE VALVE
P18	PLUG 1/8 MPT HEX HEAD 304 SS
PB12117-A	POLY BOX ASSEMBLY 12 X 11 X 7 WITH GASKET-LATCH-MOUNTING HARDWARE
PL12117	CONTROL BOX LID 12X11X7-POLYPROPYLENE-HINGED LOCKABLE LID-INCLUDES GASKET
PB12117	POLY CONTROL BOX 12X11X7

PB16138-A	16 x13 x 8 POLYPROPYLENE CONTROL BOX ASSEMBLY
PB16138	POLYPROPYLENE CONTROL BOX - WORKING DIMS 16x13x8 - PUMP MOUNT
PL16138	CONTROL BOX LID 16X13X8-POLYPROPYLENE-HINGED LOCKABLE LID-INCLUDES GASKET
PBFT-PP	MOUNTING FEET FOR POLYBOX - PB16138 - POLYPROPYLENE
PB-LTCH	POLY BOX LATCH FOR PB16138 AND PB12117
PB-PIN	STAINLESS STEEL HINGE PIN FOR PB16138 AND PB12117
PNV14	PVC 586-4F4F-T, NEEDLE
PSG12	POLY SPRAY GUN WITH 2X 1/2IN STRAIGHT THREAD - GRAY HANDLE WITH RED CLIP - 316SS INTERNAL SPRING - INCLUDES 2X O-RING
PSGORV	O-RING FOR PSG12-VITON
PW12M14F4	1/2IN NPT AND 1/4IN FNPT WAND - BLACK UHMW - 4IN LONG
PW12F10	1/2IN FNPT AND 1/2IN FNPT WAND - BLACK POLYPROPYLENE - 10IN LONG
R16	AIR REGULATOR - 1/4ft TWO PORT 1/8ft TWO PORT - NO AIR BOWL/FILTER
S1034-FH-HL	#10 X 3/4IN SCREW - STAINLESS - FLAT HEAD PHILLIPS - HILO THREAD
SEL14M	STAINLESS ELBOW 1/4IN MPT X 1/4IN MPT
SN1212	STAINLESS HEX NIPPLE 1/2 MPT X 1/2 MPT
SN1414	STAINLESS HEX NIPPLE 1/4 MPT X 1/4 MPT
SSA14	STAINLESS ADAPTOR 1/4 MPT X 1/4 FPT
SSC12	STAINLESS SCREW BAND CLAMP FOR 1/2 IN HOSE
SSC34	STAINLESS SCREW BAND CLAMP FOR 3/4 IN HOSE
SSC38	STAINLESS SCREW BAND CLAMP FOR 3/8 IN HOSE
SST12HB38	STAINLESS TEE 1/2 FPT 3/8 BARB - NO MIXING MATERIAL
SST14	STAINLESS TEE 1/4 FPT
ST2520SS	SPRAY TIP-25 DEGREE FAN-2.0 GPM-STAINLESS-1/4 MPT
ST80200SS	SPRAY TIP-80 DEGREE-20.0 GPM-STAINLESS-1/2 MPT
W387	3/8IN NPT PIPE WAND - POLISHED STAINLESS - 7IN LONG - THREADED ONE END ONLY
WMA-HH	WALL MOUNT BRACKET ASSEMBLY - HOSE HANGER - INCLUDES MOUNTING HARDWARE
WMS14	14 X 1 1/4 HEX W/H SMS SLOTT, S/S
WMS14A	5/16 X 1 1/2 STRAIGHT PLASTIC ANCHOR