USER MANUAL

**MODEL NUMBER:
SP-WC
AND RELATED UNITS**

**Wall Mounted Concentrate Spray
Unit**

English (Original Instructions)

READ ALL INSTRUCTIONS BEFORE OPERATING EQUIPMENT

WARNING



Read this manual completely and understand the machine before operating or servicing it.

- Read all instructions before installing or operating unit.
- Always wear appropriate personal protective equipment (PPE) when operating or servicing unit.
- Always follow all chemical safety precautions and handling instructions provided by the chemical manufacturer and Safety Data Sheet (SDS).
- If this unit is modified or serviced with parts not listed in this manual, the unit may not operate correctly.
- Never point the discharge wand at yourself, another person, or any object you do not want covered in chemical.
- Always depressurize unit after use (as described in the After Use Instructions). Always store unit depressurized, with the discharge valve in the closed position.
- Do not exceed an incoming air pressure of 100 psi (6.9 bar).
- Do not exceed a fluid temperature of 100°F (37.8°C).
- Always flush the unit with fresh water for thoroughly when switching from an alkaline to an acid or an acid to an alkaline.
- Only use clean and dry air. Air must be filtered and free of moisture or pump life will be diminished. If needed, install an air dryer before unit.
- Do not use an air lubricator before the unit.
- Never use unit with hydrocarbons or flammable products.

PROTECT THE ENVIRONMENT

Please dispose of packaging materials, old machine components, and hazardous fluids in an environmentally safe way according to local waste disposal regulations.



Always remember to recycle.

*Specifications and parts are subject to change without notice.

OPTIONS:	
	Pump Seal Material
SP-WC	Santoprene (<i>standard</i>)
	Viton (V)
	Kalrez (K)
Add bold option codes to item number as shown. For standard options, no option code is needed.	
Examples:	
<ul style="list-style-type: none"> • SP-WC (standard unit with Santoprene pump seals) • SP-WCV (unit with Viton pump seals) 	

READ ALL INSTRUCTIONS BEFORE OPERATING EQUIPMENT

REQUIREMENTS	
Compressed air requirements	40-80 psi (2.8-5.5 bar) with 2 cfm (56.6 l/min)
Water requirements	10-100 psi (0.7-6.9 bar) Backflow prevention is required – consult local plumbing ordinances for more information
Liquid temperature range	40-100°F (4.4-37.8°C)
Chemical compatibility	Chemical products used with this equipment must be formulated for this type of application and compatible with unit materials and pump seals. For more information on chemical compatibility, consult the manufacturer or SDS for your product or contact our customer service department.

SPECIFICATIONS	
Power type	Compressed air
Chemical pickup type	Draws from concentrated product
Dilution ratio range (water:chemical)*	34:1 to 640:1 with ST2520SS fan tip; 24:1 to 640:1 with ST2550SS fan tip
Number of products unit can draw from	One product
Suction line length/diameter	8 ft. (2.4 m) clear hose with 1/4 in. (6.4 mm) inside diameter
Discharge hose diameter/length	50 ft. (15.2 m) hose, with 1/2 in. (12.7 mm) inside diameter
Discharge wand/tip type	Polypropylene trigger handle with 25° fan tip
Output distance	10-12 ft. (3.0-3.7 m)
Output volume	2 gal/min (7.6 l/min) of liquid with ST2520SS fan tip; 4-5 gal/min (15.1-18.9 gal/min) of liquid with ST2550SS fan tip
Flow rate*	2 gal/min (7.6 l/min) with ST2520SS fan tip; 4-5 gal/min (15.1-18.9 l/min) with ST2550SS fan tip
Pump seals	Santoprene, Viton, or Kalrez

*Dilution rates and flow rates given are based on chemical with viscosity of water and factory air pressure settings.

READ ALL INSTRUCTIONS BEFORE OPERATING EQUIPMENT

Installation Instructions:

1. Remove all components from packaging.
2. Select desired area to mount the control box.
Note: We recommend mounting the control box at a height of 6 feet or less. The chemical suction lines must reach the bottom of the chemical container. The bottom of the chemical container should not be positioned higher than the bottom of the control box.
3. Attach the control box mounting feet to the back of the control box, using the four screws provided in the parts package.
4. Mount the control box to the wall using four of the screws and plastic anchors provided in the parts package.
Note: To drill holes for the plastic anchors, use a 5/16 inch drill bit.
5. Mount the hose hanger in a convenient location using the remaining two screws and anchors provided in the parts package.
6. Attach the discharge hose assembly to the discharge hose barb and secure it with the larger hose clamp provided in the parts package.
7. Connect the air inlet hose barb provided in the parts package to the air inlet valve located on the side of the control box. Then attach a 3/8 inch I.D. air line from your air compressor to the air inlet hose barb, and secure it with the smaller hose clamp provided in the parts package.
8. Connect a water line to the unit. The control box has a 1/2 inch FPT water inlet fitting. A garden hose adapter fitting assembly is included in the parts package.
Note: A back-flow preventer must be installed in the water line – check local plumbing codes to ensure proper installation.
9. Insert the proper metering tips and connect the chemical intake lines to the inlet barbs. **Note:** Use the included metering tip color charts to determine the appropriate metering tip based on the product and dilution rate you will be using.
10. Place the other end of each chemical intake line into a chemical container.

METERING TIP COLOR CHART FOR SANITIZE FUNCTION

Metering tip color	WITH ST2520SS FAN TIP		WITH ST2550SS FAN TIP	
	Ounces of chemical per gallon of water*	Dilution ratio (water:chemical)*	Ounces of chemical per gallon of water*	Dilution ratio (water:chemical)*
Copper	0.20	640:1	0.20	640:1
Pumpkin	0.30	427:1	0.30	427:1
Burgundy	0.40	320:1	0.40	320:1
Lime	0.41	312:1	0.41	312:1
Tan	0.42	305:1	0.42	305:1
Orange	0.54	237:1	0.67	191:1
Turquoise	0.61	209:1	0.72	177:1
Pink	1.01	127:1	1.18	108:1
Light blue	1.28	106:1	1.42	90:1
Brown	1.35	95:1	1.52	84:1
Red	1.82	70:1	2.7	47:1
White	1.89	67:1	2.8	46:1
Green	2.09	61:1	3.0	43:1
Blue	2.70	47:1	3.31	38:1
Yellow	3.71	34:1	5.2	24:1
No tip	7.37	17:1	13.5	10:1

*Injection rates will vary based on chemical viscosity, air pressure, and many other factors. We recommend testing unit output to verify injection rate prior to use.

READ ALL INSTRUCTIONS BEFORE OPERATING EQUIPMENT

Operation Instructions:

1. Follow all instructions from chemical manufacturer.
2. With the discharge valve in the closed position, open the air inlet valves.
3. Point the spray discharge wand in a safe direction and open the discharge valve to begin spraying. The discharge valve should be completely open while spraying.
4. To stop spraying, close the discharge valve.

After Use Instructions:

1. Place the chemical suction line into a container of water.
2. With the unit running, open the discharge valve, and allow the unit to be flushed with fresh water thoroughly until all chemical has been discharged from the unit.
3. Shut off the air supply to the unit by closing air inlet valve.
4. Shut off the water supply to the unit.
5. Open the discharge valve to relieve any pressure remaining in the unit.
6. Close the discharge valve after all pressure has been relieved from the unit. Store the unit with the discharge valve in the closed position.

Maintenance Instructions:

To keep the unit operating properly, periodically perform the following maintenance procedures:

Note: Before performing any maintenance, disconnect the unit from the compressed air and water supply and depressurize it as described in the After Use Instructions.

- Inspect the pump for wear and leaks.
- Inspect all hoses for leaks or excessive wear. Make sure all hose clamps are in good condition and properly secured.
- Replace the filter located within the air regulator as needed. Clean by unthreading the air regulator bowl from the air regulator.
- Check the chemical metering tips, intake lines and strainers for debris and clean as needed.
- Drain the air compressor tank on a regular basis to help extend pump life. An air source with a high moisture content will accelerate pump wear. **Note:** If the air source has a high moisture content, you may wish to install a water separator before the unit.

Troubleshooting Instructions:

- Check to ensure that the discharge hose is uncoiled properly, and that there are no kinks that could obstruct fluid flow.
- Check the air regulator bowl and air filter for debris such as water, oil, or rust particles. Clean by unthreading the air regulator bowl from the air regulator.
- If air passes through the pump without cycling, the pump needs to be replaced.
- Check for proper air pressure on the air gauge. The air regulator factory set at 50 psi (3.4 bar). Operating range is 40-80 psi (2.8-5.5 bar) with 5-10 cfm (141.6-283.2 l/min).
- If the unit operates at a reduced pressure:
 - Check the air compressor supplying the unit. If the pressure is less than 40 psi (2.8 bar), turn the unit off until the compressor can catch up.
 - If the air supply is 50 psi (3.4 bar) or above, check the air gauge, which should read near 50 psi (3.4 bar). If the air gauge reads more or less than 50 psi (3.4 bar), adjust the pressure by turning the knob on the top of the air regulator.
- Check the chemical metering tips, intake lines and strainers for debris or damage. Clean or replace as needed. To prevent damage to the unit, strainers must always be used.
- Check for proper water pressure on the water pressure gauge. To check the pressure:
 - With the unit running, open the discharge valve and allow the unit to run for about 1 minute.
 - Close the discharge valve.
 - Check the water pressure gauge. The pressure should read 30 psi (2.1 bar).
 - If necessary, adjust the water regulator using the flathead screw on the regulator body. The water pressure should be set at 30 psi (2.1 bar). Setting the pressure higher or lower may damage the unit or cause it to malfunction.

READ ALL INSTRUCTIONS BEFORE OPERATING EQUIPMENT

PARTS DIAGRAMS - UNITS WITH STANDARD FITTINGS

CONTROL BOX ASSEMBLY

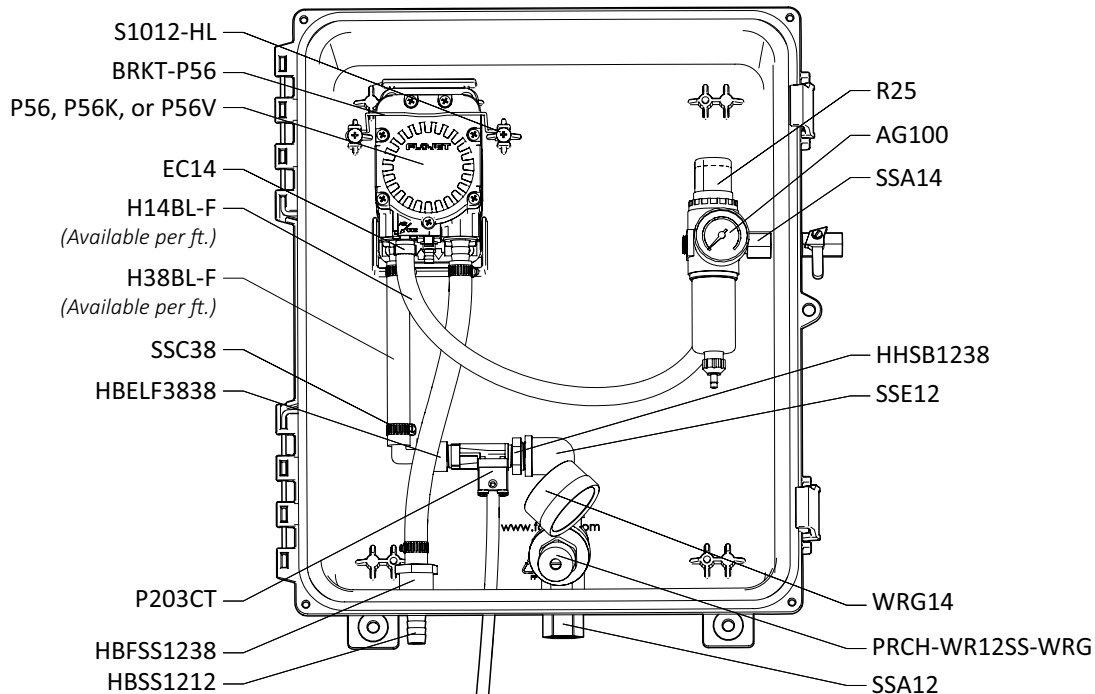

CONTROL BOX ASSEMBLY OUTSIDE VIEW

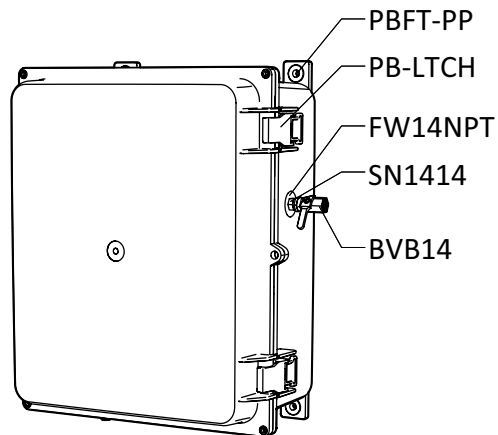

READ ALL INSTRUCTIONS BEFORE OPERATING EQUIPMENT

PARTS DIAGRAMS

HOSE AND WAND ASSEMBLY ITEM NUMBER: PSGA124-ST-HA12BL-50

SPRAY GUN ASSEMBLY ITEM NUMBER: PSGA124-ST

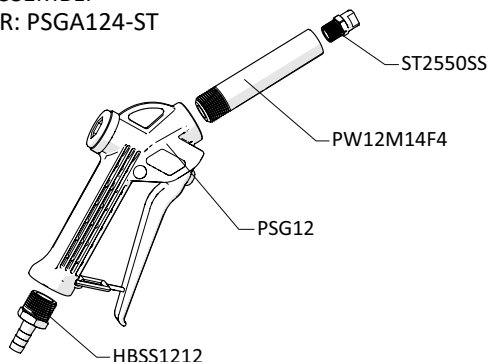

50 ft (15 m) HOSE ASSEMBLY ITEM NUMBER: HA12BL-50

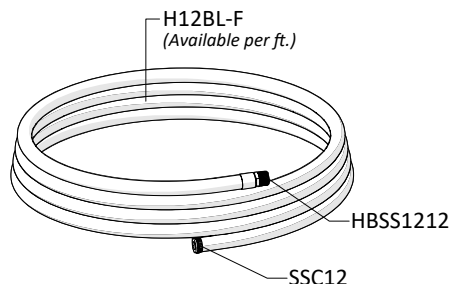

ANTI-KINK SPRING ASSEMBLY ITEM NUMBER: AKSS12

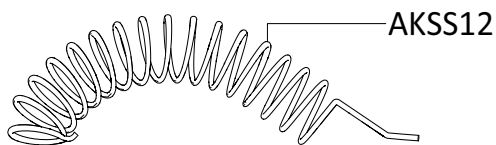

OPTIONAL COMPONENT WATER SEPARATOR ASSEMBLY ITEM NUMBER: WSA-20CFM

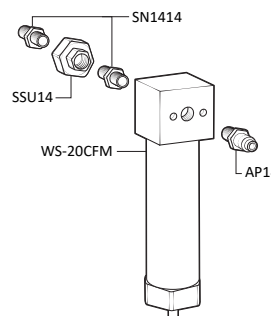

LEGACY WATER REGULATOR ASSEMBLY

LEGACY PARTS DIAGRAM

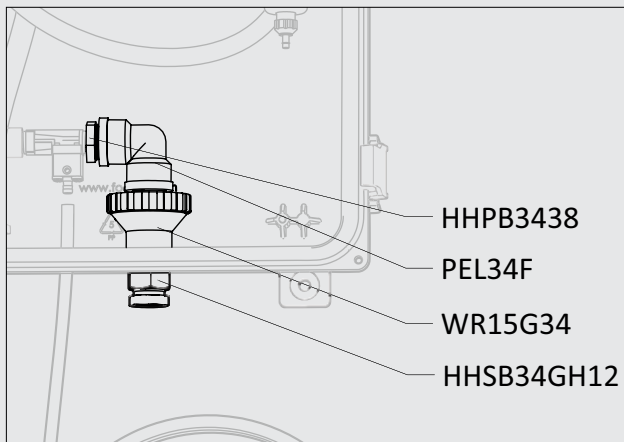

LEGACY PARTS LIST

ITEM NUMBER	DESCRIPTION
HHPB3438	HEX HEAD POLY REDUCER BUSHING 3/4in X 3/8in
HHSB34GH12	STAINLESS HEX HEAD BUSHING 3/4in MGH BY 1/2 FPT
PEL34F	3/4in FEMALE POLY PIPE ELBOW 90
WR15G34	WATER PRESSURE REGULATOR - 3/4in FGH BY 3/4in MPT Body ABS, internal parts, SS, PP and Santo

Conversion kit to upgrade to current water inlet: CK-WR12SS.

READ ALL INSTRUCTIONS BEFORE OPERATING EQUIPMENT

ITEM NUMBER	DESCRIPTION
AG100	AIR GAUGE-1/8IN NPT-100 PSI DRY MODEL
AKSS12	SS ANTI-KINK SPRING FOR 1/2 INCH HOSE
BRKT-P56	PUMP BRACKET- STAINLESS STEEL
BVB14	BALL VALVE - BRASS - NICKEL PLATED - AIR INLET VALVE - 1/4IN FPT X 1/4IN FPT
EC14	EAR CLAMP - OETIKER - STAINLESS STEEL - FOR 1/4IN HOSE
F12SS	FERRULE FOR 1/2IN HOSE - STAINLESS
FW14NPT	FLAT WASHER FOR 1/4IN NPT - STAINLESS - 0.57IN ID X 1.28IN OD X 0.08IN THK
FW12NPT	FLAT WASHER FOR 1/2IN NPT - STAINLESS - 0.88IN ID X 1.5IN OD X 0.05IN THK
FW12NPT-THK	FLAT WASHER FOR 1/2IN NPT - THICK - STAINLESS - 0.88IN ID X 1.5IN OD X 0.12IN THK
H12BL-F	1/2IN ID BLUE HOSE-HYBRID TPE-AVAILABLE PER FT
H14BL-F	1/4IN ID BLUE HOSE-HYBRID TPE-AVAILABLE PER FT
H316CL-PV	3/16IN ID 5/16IN OD CLEAR HOSE - PVC - AVAILABLE PER FT
H38BL-F	3/8IN ID BLUE HOSE-HYBRID TPE-AVAILABLE PER FT
HBELF3838	HOSE BARB ELBOW 3/8 IN BY FPT 3/8 IN
HBFSS1238	HOSE BARB - STAINLESS STEEL - 1/2IN FPT X 3/8IN BARB
HBSS1212	HOSE BARB - STAINLESS STEEL - 1/2IN MPT X 1/2IN BARB
HBSS1438	HOSE BARB - STAINLESS STEEL - 1/4IN MPT X 3/8IN BARB
HBSSEL1814	HOSE BARB - STAINLESS STEEL - ELBOW - 1/8IN MPT X 1/4IN BARB
HHSB1238	HEX HEAD STAINLESS BUSHING 1/2 MPT X 3/8 FPT
MTK832-UL	METERING TIP KIT - 8-32 THREAD - DEMA ULTRALEAN - INCLUDES ALL FOUR COLORS
P14-VS	COUNTERSUNK PLUG-HEXAGON 1/4 w/VIBRAL SEAL PATCH
P203CT	PLASTIC INJECTOR KIT INCLUDES INJECTOR - INTAKE HOSE - FOOT STRAINER AND WEIGHT - TIP KIT
P56	PUMP WITH SANTOPRENE SEALS - INCLUDES HOSE BARBS, AIR FITTING, AND EXHAUST BARB
P56K	PUMP WITH KALREZ SEALS - INCLUDES HOSE BARBS, AIR FITTING, AND EXHAUST BARB
P56V	PUMP WITH VITON SEALS - INCLUDES HOSE BARBS, AIR FITTING, AND EXHAUST BARB
<i>HBB14P</i>	1/4IN HOSE BARB-BRASS-FOR G57/P56 AIR FITTING WITH O-RING
<i>HB5638</i>	HOSE BARB FOR P56 PUMP
<i>HB5638K</i>	HOSE BARB FOR P56K PUMP
<i>HB5638V</i>	HOSE BARB FOR P56V PUMP
PB16138-A	16 x13 x 8 POLYPROPYLENE CONTROL BOX ASSEMBLY
PB16138	POLYPROPYLENE CONTROL BOX - WORKING DIMS 16x13x8 - PUMP MOUNT
PB-LTCH	POLY BOX LATCH FOR PB16138 AND PB12117
PB-PIN	STAINLESS STEEL HINGE PIN FOR PB16138 AND PB12117
PBFT-PP	MOUNTING FEET FOR POLYBOX - PB16138 - POLYPROPYLENE

ITEM NUMBER	DESCRIPTION
PL16138	CONTROL BOX LID - POLYPROPYLENE - 16x13x8 - HINGED LOCKABLE LID WITH GASKET
PSG12	POLY SPRAY GUN WITH 2X 1/2IN STRAIGHT THREAD - GRAY HANDLE WITH RED CLIP - 316SS INTERNAL SPRING - INCLUDES 2X O-RING
<i>PSGORV</i>	O-RING FOR PSG12-VITON
PW12M14F4	1/2IN NPT AND 1/4IN FNPT WAND - BLACK UHMW - 4IN LONG
R25	AIR REGULATOR INCLUDES AIR FILTER AND BOWL
<i>AFR25</i>	AIR FILTER for R25
<i>ABR25</i>	METAL AIR BOWL for R25
S1012-HL	SCREW - #10 X 1/2IN - STAINLESS STEEL - ROUND HEAD PHILLIPS - HILO THREAD
S1034-FH-HL	SCREW - #10 X 3/4IN - STAINLESS STEEL - FLAT HEAD PHILLIPS - HILO THREAD
SN1414	STAINLESS HEX NIPPLE 1/4 MPT X 1/4 MPT
SSA12	STAINLESS ADAPTOR 1/2 MPT X 1/2 FPT
SSA14	STAINLESS ADAPTOR 1/4 MPT X 1/4 FPT
SSC12	SCREW BAND CLAMP - STAINLESS STEEL - FOR 1/2IN HOSE
SSC38	SCREW BAND CLAMP - STAINLESS STEEL - FOR 3/8IN HOSE
SSE12	STAINLESS STREET ELBOW - 304 STAINLESS STEEL - 1/2IN FPT X 1/2IN MPT
ST2520SS	SPRAY TIP-25 DEGREE FAN-2.0 GPM-STAINLESS-1/4 MPT
ST2550SS	SPRAY TIP-25 DEGREE FAN-5.0 GPM-STAINLESS-1/4 MPT
STR34	1in SEAL/STRAINER FOR 3/4 GH FITTINGS
SSU14	STAINLESS STEEL UNION- 1/4 INCH FP
SSWVLA12	STAINLESS GARDEN HOSE SWIVEL ADAPTER X 1/2 MPT
SSWVLN34GH	STAINLESS GARDEN HOSE SWIVEL NUT 3/4IN GHT
ST2520SS	SPRAY TIP-25 DEGREE FAN-2.0 GPM-STAINLESS-1/4 MPT
ST2550SS	SPRAY TIP-25 DEGREE FAN-5.0 GPM-STAINLESS-1/4 MPT
STR34	1in SEAL/STRAINER FOR 3/4 GH FITTINGS
WMA-HH	WALL MOUNT BRACKET ASSEMBLY - HOSE HANGER - INCLUDES MOUNTING HARDWARE
WMS14	WALL MOUNT SCREW - #14 X 1 1/4IN - STAINLESS STEEL - HEX HEAD SLOTTED
WMS14A	WALL MOUNT SCREW ANCHOR -#14 X 1 1/4IN - PLASTIC - 5/16IN DRILL SIZE
PRCH-WR12SS-WRG	WATER PRESSURE REGULATOR - STAINLESS STEEL - FKM SEALS - 1/2IN FPT - ASSEMBLED WITH GAUGE
WRG14	WATER PRESSURE REGULATOR GAUGE FOR WR12SS
WSA-20CFM	WATER SEPARATOR ASSEMBLY-20CFM-1/4IN FPT PORTS- INCLUDES AIR PLUG, UNION FITTINGS